



McCue

mccue.com 

cservices@mccue.com 



SHOCK-ABSORBING *RACKGUARDS*

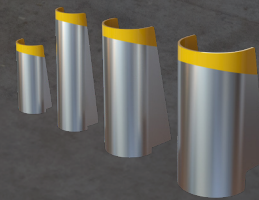

INDUSTRIAL SHOCK-ABSORBING RACK PROTECTION

**KEEP YOUR OPERATIONS SAFE AND YOUR WORKFORCE SAFER WITH THE WORLD'S
MOST ADVANCED SAFETY BARRIERS — SPEAK TO A SAFETY SPECIALIST TODAY**

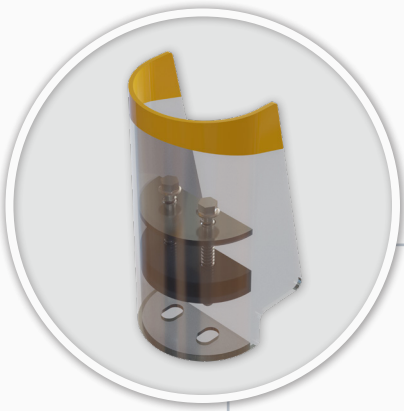

CONCEALED IMPACT TECHNOLOGY:

Hidden elastomer absorbs impacts so your racks don't get hit.

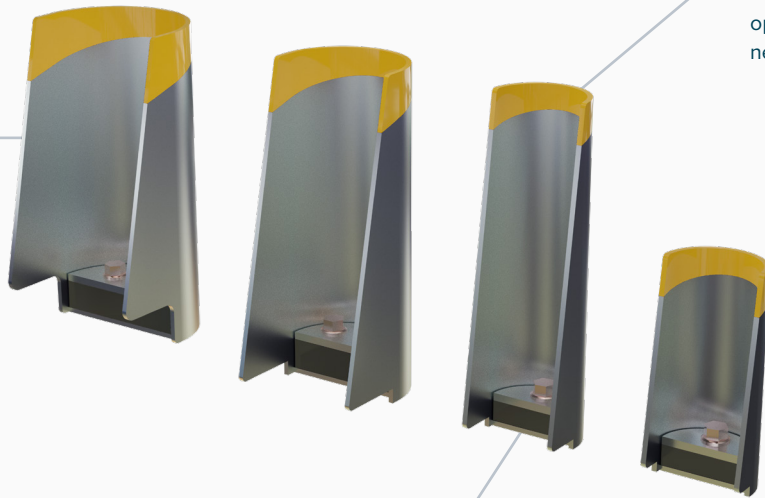

HIGHLY VISIBLE TOP:
Bright yellow top is easier for operators to see when working in nearby rack bays.

SLIM HALF-ROUND DESIGN:
Curved designs are super strong and they deflect glancing impacts.

SIMPLE CONCRETE ANCHOR INSTALLATION:
Easily installs with 1 or 2 anchors.

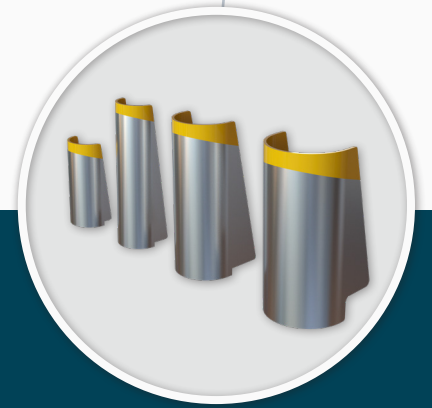

SHOCK-ABSORBING RACKGUARDS

Our **Shock-Absorbing RackGuards** are engineered to protect your racking uprights against damaging blows from material handling equipment. The slim, half-round design minimizes floor space required, and it mounts to the concrete floor in front of the upright — so impacts are absorbed by the guard, not your racking system.

SMALL FOOTPRINT, *ULTIMATE PROTECTION*

Available in multiple sizes, our rack protectors provide a snug fit for any upright — delivering maximum protection with a minimal footprint

COMPACT DESIGN:

Sits close to racking.

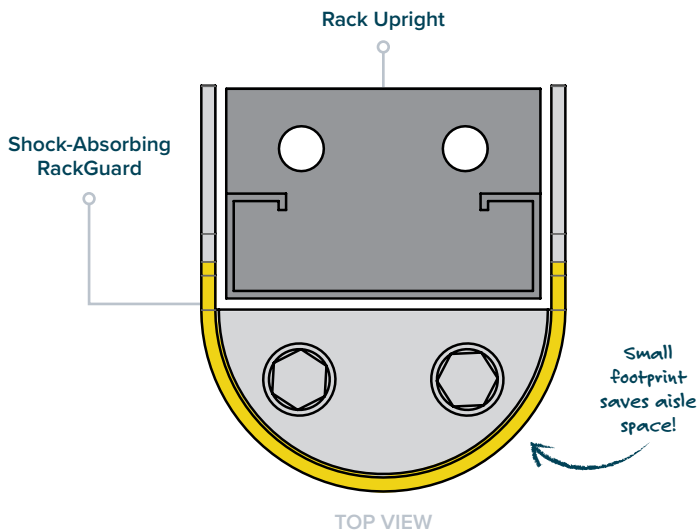

SHOCK-ABSORBING *RACKGUARD*

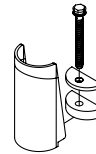
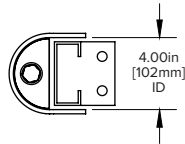
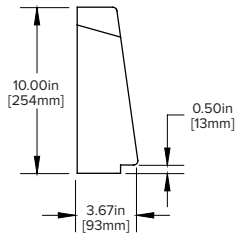

Shock-Absorbing RackGuard 4" (102mm) Wide

4" (102mm) Wide x 10" (254mm) Tall

Part Number: RG-K-410-307

Use: Standard Racking

Materials: Zinc Plated Steel,
Rubber Damper & Anchor Kit

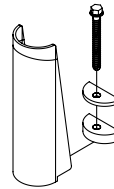
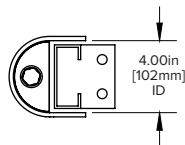
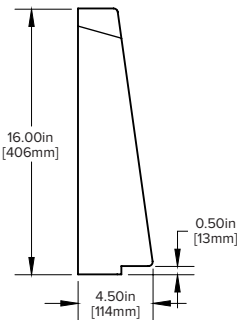

Shock-Absorbing RackGuard 4" (102mm) Wide

4" (102mm) Wide x 16" (406mm) Tall

Part Number: RG-K-416-307

Use: Standard Racking

Materials: Zinc Plated Steel,
Rubber Damper & Anchor Kit

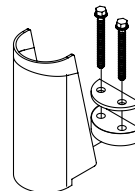
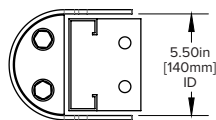
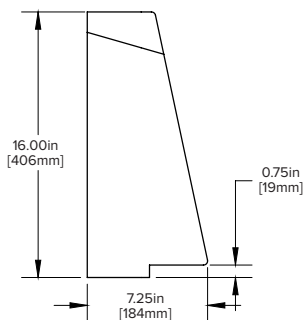

Shock-Absorbing RackGuard 5.5" (140mm) Wide

5.5" (140mm) Wide x 16" (406mm) Tall

Part Number: RG-K-516-307

Use: Heavy Duty Racking

Materials: Zinc Plated Steel,
Rubber Damper & Anchor Kit

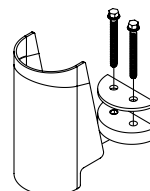
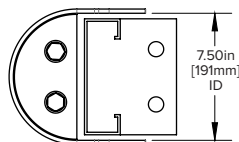
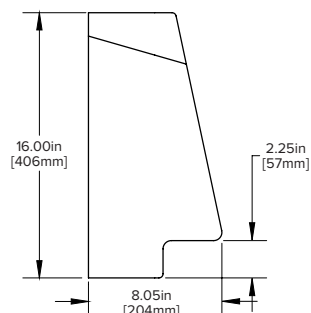

Shock-Absorbing RackGuard 7.5" (191mm) Wide

7.5" (191mm) Wide x 16" (406mm) Tall

Part Number: RG-K-716-307

Use: Seismic Racking

Materials: Zinc Plated Steel,
Rubber Damper & Anchor Kit